

Typical Features

- ◆ Wide Input Voltage Range (2:1), Output Power 3W
- ◆ High Efficiency up to 80%
- ◆ With remote control Switch-off function
- ◆ Continuous Short Circuit protection, Self-recovery
- ◆ Input under voltage, output over current protection
- ◆ Isolation Voltage 3000VDC
- ◆ Operating Temperature: -40℃ ~ +85℃
- ◆ Plastic Case, meet UL94 V-0 standard

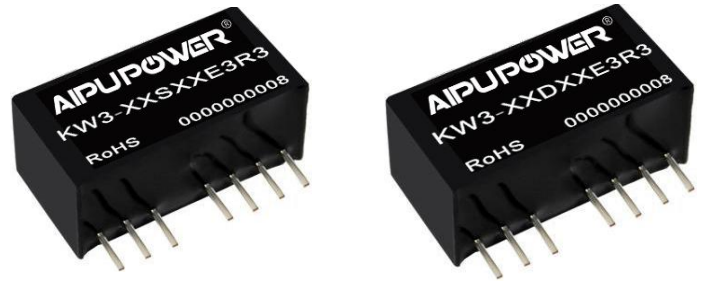

Test Condition: Unless otherwise specified, data in the datasheet should be tested under the conditions of inputting nominal voltage, pure resistance rated load and Ta=25℃

Application Field

It could be widely used for instrument, communication, pure digital circuit, general low frequency analog circuit, relay drive circuit, data exchange circuit, etc.

Typical Product List

Part No.	Input Voltage Range (VDC)		Output Voltage/Current (Vo/Io)		Input Current(mA) Nominal Voltage		Max. Capacitive Load uF	Ripple & Noise (Max.) mVp-p	Efficiency (%)@output full load, input nominal voltage	
	Nominal	Range	Voltage (VDC)	Current(mA) MAX.	Full load Typ.	No Load Typ.			Min.	Typ.
KW3-05S05E3R3	5	4.5 -9	5	600	851	6	1000	100	70	74
KW3-05S09E3R3			9	333	756	6	680	100	73	77
KW3-05S12E3R3			12	250	742	6	330	100	73	77
KW3-05S15E3R3			15	200	756	8	220	100	73	77
KW3-05S24E3R3			24	125	782	8	100	100	74	78
KW3-05D05E3R3	5	4.5 -9	±5	±300	853	6	470	100	70	74
KW3-05D09E3R3			±9	±167	758	6	330	100	73	77
KW3-05D12E3R3			±12	±125	746	6	220	100	73	77
KW3-05D15E3R3			±15	±100	756	8	100	100	74	78

1. The capacitive load of positive and negative output is same.

Input Specifications

Item	Test Condition	Min.	Typ.	Max.	Unit
Max Input Overshoot Voltage	4.5-9V Input	-0.7	-	12	VDC
Turn-on Voltage	5V Input	--	--	4.5	VDC
Control Pin (Ctrl)	High level or floating enable, with output	3.5	-	12	VDC
	Low level or connected to input ground, no output	0	-	1.2	
Stand-by Power Consumption	0.5W (Max.)				

Input Filter	Capacitor Filter
--------------	------------------

Note: Voltage of control pin(Ctrl) is related to input GND.

Output Specifications

Positive Output Voltage Accuracy	Full voltage full load	+Vo	≤±2.0%
Negative Output Voltage Accuracy		-Vo	≤±3.0%
No Load Output Voltage Accuracy		Vo	Primary Output:≤±3.0%, Secondary Output:≤±5.0%
Line Regulation	Nominal load, full voltage range	Vo	Primary Output:≤±0.2%, Secondary Output:≤±0.5%
Load Regulation	10% ~ 100% nominal load	Vo	Primary Output:≤±0.5%, Secondary Output:≤±3%
Cross Regulation	Dual output, Primary output 50% load, secondary output 10%-100% load		≤±5.0%
Ripple & Noise*	Nominal load, nominal voltage		≤100mVp-p (20MHz bandwidth)
Temperature Drift Coefficient	100% full load		±0.03%/°C
Dynamic Response	25% nominal load step change	ΔVo/Δt	≤±5.0%/0.5ms(Typ.)
Output Short Circuit Protection	Continuous, Self-recovery		

Note: 1. Un-balancing loads of dual output:±5%;

2. Ripple & Noise Tested by twisted-pair method, for details please check Design and Application Circuit.

General Specifications

Switching Frequency	typical	450KHz (Typ.)
Operating Temperature	Refer to Temperature Derating	-40°C ~ +85°C
Storage Temperature		-55°C ~ +125°C
Max Case Temperature	Within Temperature Derating	+105°C
Relative Humidity	No condensing	5%~95%
Case Material		Black flame-retardant heat-resistant Plastic(UL94 V-0)
Pin withstand welding temp	Distance to case 1.5mm, 10s	300°C MAX
Isolation Voltage	Input to Output	3000Vdc ≤ 0.5mA / 1min
MTBF	MIL-HDBK-217F@25°C	2X10 ⁵ Hrs
Product Weight		4.5g(Typ.)
Package	Tube(225*20.5*12.5mm)	9PCS
	Inner Box(245*155*85mm)	432PCS(Total 48Tubes)

Packing Dimension

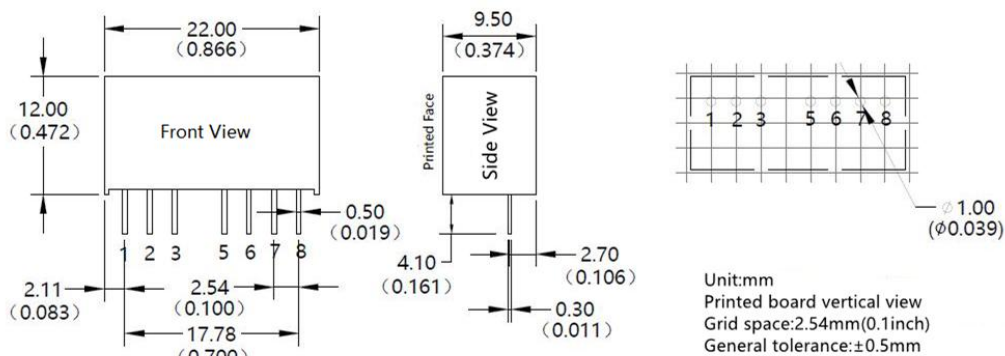

Packing Code	L x W x H							
E	22X9.5X12mm					0.866X0.374X0.472inch		

Pin Function

Pin-Out	1	2	3	4	5	6	7	8
Single(S)	GND	+Vin	Ctrl	NP	NC	+Vo	0V	CS
Dual(D)	GND	+Vin	Ctrl	NP	NC	+Vo	0V	-Vo

Note: if the definition of pin is not in accordance with the model selection manual, please refer to the label on actual item.

Ripple & Noise Test: (Twisted Pair Method 20MHZ bandwidth)

a. 12# twisted pair to connect, Oscilloscope bandwidth set as 20MHz, 100M bandwidth probe, terminated with 0.1uF polypropylene capacitor and 10uF high frequency low resistance electrolytic capacitor in parallel, oscilloscope set as Sample pattern.

b. Input terminal connect to power supply, output terminal connect to electronic load through jig plate, Use 30cm±2 cm sampling line, Power line selected from corresponding diameter wire with insulation according to the flow of output current.

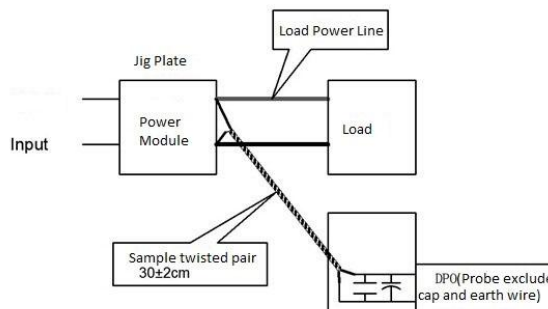

Product Temperature Curve

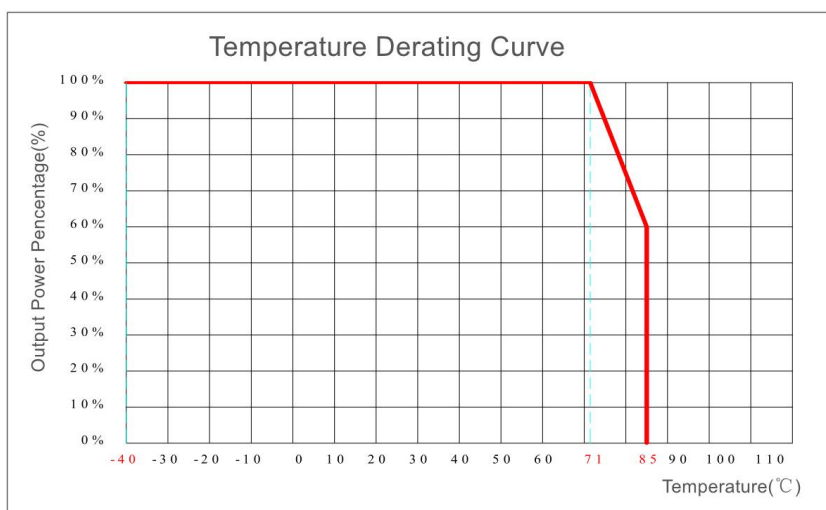

Design and Application Circuit Recommended

1.CS terminal

This terminal provides a connection point to connect the inside main filter capacitor of output terminal for the DC/DC converter(capacitor positive) , and can further improve the output ripple and noise through connecting a low ESR capacitor(Normal CS≤47uF) between this terminal and the 7 pin (capacitor negative).

2. Output Load Request

a. To ensure this module operate efficiently and reliably, the minimum load recommended not to be less than 10% of the nominal load. If the actual power is too small, please connect a resistor in parallel at output terminal, the resistance equal to 10% nominal load. If use positive negative dual output product, please try to avoid big unbalances between loads, or the original output voltage accuracy cannot be ensured.

b. The maximum capacitive load is tested under nominal input full load; if use it under no load condition, should try to decrease the output capacitive load or connect a resistor in parallel at output terminal, the resistance equal to 10% nominal load, otherwise it may cause the output voltage be un-stable or even exceed the original output voltage accuracy range

3.Recommended Circuit

DC/DC test circuit: If customers want to further decrease input& output ripple, the capacitance of external capacitor can be increased properly, but the maximum capacitance of the filter capacitor should be less than the maximum capacitive load, otherwise it will make it difficult to turn-on the module.

Single

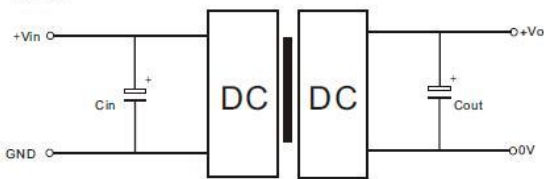

Recommended capacitive load value table(Photo 1)

Vout (Vdc)	Cin (μF)	Cout (μF)	双路 Vout (Vdc)	Cin (μF)	Cout (μF)
3, 3/5/9	100 μF/25V	22 μF/16V	±3, 3/±5/±9	100 μF/50V	22 μF/16V
12/15		22 μF/25V	±12/±15		22 μF/25V
24		10 μF/50V	±24		10 μF/50V

Dual

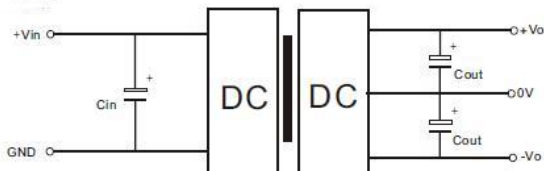

4.CTRL Terminal

Positive logic is enabled, the module works normally when the control pin is connected to a high level or suspended, and is turned off when it is grounded or low.

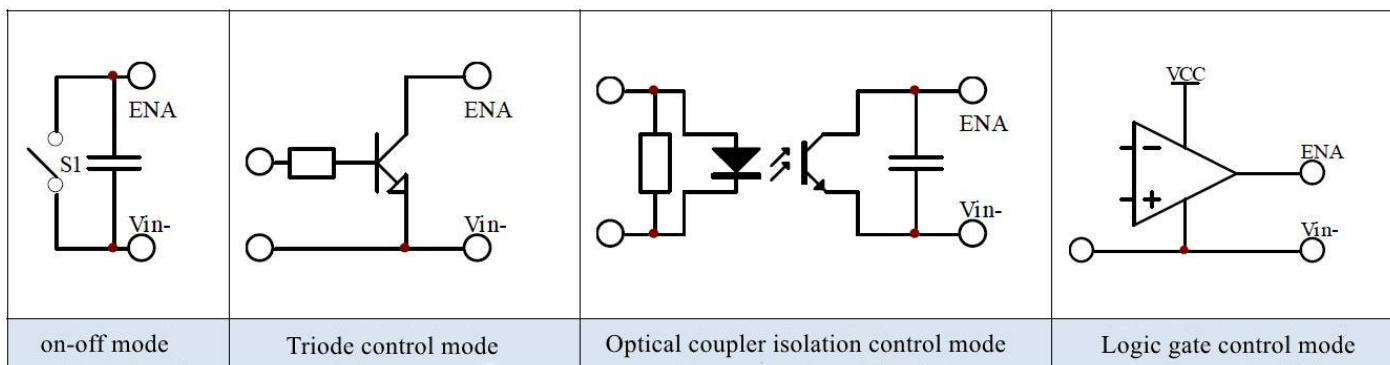

Note:

- 1.This product cannot be used in parallel, and do not support hot-plugging;
2. All index testing methods in this datasheet are based on our Company's corporate standards
3. The product specification may be changed at any time without prior notice.

Guangzhou Aipu Electron Technology Co., Ltd

Address: Building 4, HEDY Park, No.63, Punan Road, Huangpu Dist, Guangzhou, China.

Tel: 86-20-84206763 Fax: 86-20-84206762 HOTLINE: 400-889-8821

E-mail: sales@aipu-elec.com Website: www.aipupower.com